

FEATURES

- Isolated high-side and low-side outputs**
- Working voltage**
 - High side or low side relative to input: ± 350 V peak**
 - High side/low side differential: 350 V peak**
- 4 A peak output current**
- High frequency operation: 1 MHz maximum**
- High common-mode transient immunity: >25 kV/ μ s**
- High temperature operation: 105°C**
- Narrow body, 16-lead SOIC**
- Safety and regulatory approvals**
 - UL recognition**
 - 1000 V rms for 1 minute per UL 1577**

APPLICATIONS

- Isolated IGBT/MOSFET gate drives**
- Plasma displays**
- Industrial inverters**
- Switching power supplies**

GENERAL DESCRIPTION

The ADuM7234¹ is an isolated, half-bridge gate driver that uses the Analog Devices, Inc., *iCoupler*® technology to provide independent and isolated high-side and low-side outputs. Combining high speed CMOS and monolithic transformer technology, this isolation component provides outstanding performance characteristics superior to optocoupler-based solutions.

By avoiding the use of LEDs and photodiodes, this *iCoupler* gate drive device is able to provide precision timing characteristics not possible with optocouplers. Furthermore, the reliability and performance stability problems associated with optocoupler LEDs are avoided.

In comparison to gate drivers that use high voltage level translation methodologies, the ADuM7234 offers the benefit of true, galvanic isolation between the input and each output and between each input. Each output can be operated at up to ± 350 V peak relative to the input, thereby supporting low-side switching to negative voltages. The differential voltage between the high side and low side can be as high as 350 V peak.

As a result, the ADuM7234 provides reliable control over the switching characteristics of IGBT/MOSFET configurations over a wide range of positive or negative switching voltages.

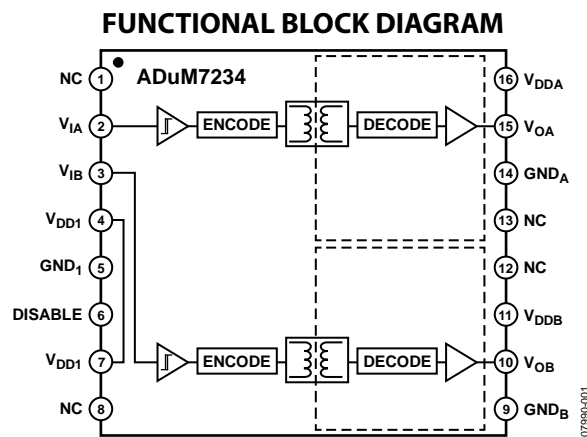

Figure 1.

¹ Protected by U.S. Patents 5,952,849 and 6,291,907.

TABLE OF CONTENTS

| | | | |
|--|---|--|----|
| Features | 1 | Regulatory Information..... | 4 |
| Applications..... | 1 | Absolute Maximum Ratings | 5 |
| General Description | 1 | ESD Caution..... | 5 |
| Functional Block Diagram | 1 | Pin Configuration and Function Descriptions..... | 6 |
| Revision History | 2 | Typical Performance Characteristics | 7 |
| Specifications..... | 3 | Applications Information | 8 |
| Electrical Characteristics | 3 | Common-Mode Transient Immunity | 8 |
| Package Characteristics | 4 | Insulation Lifetime | 9 |
| Insulation and Safety-Related Specifications | 4 | Outline Dimensions | 10 |
| Recommended Operating Conditions | 4 | Ordering Guide | 10 |

REVISION HISTORY

2/13—Rev. A to Rev. B

| | |
|---|---|
| Created Hyperlink for Safety and Regulatory Approvals | |
| Entry in Features Section..... | 1 |
| Change to Table 5 | 4 |

1/10—Revision A: Initial Version

SPECIFICATIONS

ELECTRICAL CHARACTERISTICS

All voltages are relative to their respective grounds. $4.5\text{ V} \leq V_{DD1} \leq 5.5\text{ V}$, $12\text{ V} \leq V_{DDA} \leq 18\text{ V}$, and $12\text{ V} \leq V_{DDB} \leq 18\text{ V}$. All minimum/maximum specifications apply over the entire recommended operating range, unless otherwise noted. All typical specifications are at $T_A = 25^\circ\text{C}$, $V_{DD1} = 5\text{ V}$, $V_{DDA} = 15\text{ V}$, and $V_{DDB} = 15\text{ V}$.

Table 1.

| Parameter | Symbol | Min | Typ | Max | Unit | Test Conditions/ Comments |
|--|-------------------------------|---------------------------------------|--------------------|----------------------|----------------------|--|
| DC SPECIFICATIONS | | | | | | |
| Input Supply Current, Quiescent | $I_{DD(Q)}$ | | 1.0 | 2.2 | mA | |
| Output Supply Current A or Output Supply Current B, Quiescent | $I_{DDA(Q)}, I_{DDB(Q)}$ | | 1.5 | 3.2 | mA | |
| Input Supply Current, 2 Mbps | $I_{DD(2)}$ | | 1.4 | 3.0 | mA | |
| Output Supply Current A or Output Supply Current B, 2 Mbps | $I_{DDA(2)}, I_{DDB(2)}$ | | 22 | 30 | mA | $C_L = 1000\text{ pF}$ |
| Input Currents | $I_{IA}, I_{IB}, I_{DISABLE}$ | -10 | +0.01 | +10 | μA | $0\text{ V} \leq V_{IA}, V_{IB}, V_{DISABLE} \leq V_{DD1}$ |
| Logic High Input Threshold | V_{IH} | $0.7 \times V_{DD1}$ | | | V | |
| Logic Low Input Threshold | V_{IL} | | | $0.3 \times V_{DD1}$ | V | |
| Logic High Output Voltages | V_{OAH}, V_{OBH} | $V_{DDA} - 0.15,$ $V_{DDB} - 0.15$ | V_{DDA}, V_{DDB} | | V | $I_{OA}, I_{OB} = -20\text{ mA}$ |
| Logic Low Output Voltages | V_{OAL}, V_{OBL} | | | 0.15 | V | $I_{OA}, I_{OB} = 20\text{ mA}$ |
| Undervoltage Lockout, V_{DDA} or V_{DDB} Supply | UVLO | | | | | |
| Positive-Going Threshold | V_{DDBUV+} | 8.0 | 8.9 | 9.8 | V | |
| Negative-Going Threshold | V_{DDBUV-} | 7.4 | 8.2 | 9.0 | V | |
| Hysteresis | V_{DDBUVH} | 0.3 | 0.7 | | V | |
| Output Short-Circuit Pulsed Current ¹ | $I_{OA(SC)}, I_{OB(SC)}$ | 2.0 | 4.0 | | A | |
| SWITCHING SPECIFICATIONS | | | | | | |
| Minimum Pulse Width ² | PW | | | 100 | ns | $C_L = 1000\text{ pF}$ |
| Maximum Switching Frequency ³ | | 2 | | | Mbps | |
| Propagation Delay ⁴ | t_{PHL}, t_{PLH} | 130 | 160 | 200 | ns | |
| Change vs. Temperature | | | 130 | | ps/ $^\circ\text{C}$ | |
| Pulse Width Distortion, $ t_{PLH} - t_{PHL} $ | PWD | | | 14 | ns | |
| Channel-to-Channel Matching, Rising or Falling Edges ⁵ | | | | 11 | ns | |
| Channel-to-Channel Matching, Rising vs. Falling Edges ⁶ | | | | 25 | ns | |
| Part-to-Part Matching, Rising or Falling Edges ⁷ | | | | 55 | ns | Input $t_r = 3\text{ ns}$ |
| Part-to-Part Matching, Rising vs. Falling Edges ⁸ | | | | 63 | ns | Input $t_r = 3\text{ ns}$ |
| Output Rise/Fall Time (10% to 90%) | t_r/t_f | 8 | 14 | 30 | ns | |

¹ Short-circuit duration less than 1 sec. Average power must conform to the limit shown in the Absolute Maximum Ratings section.

² The minimum pulse width is the shortest pulse width at which the specified timing parameters are guaranteed.

³ The maximum switching frequency is the maximum signal frequency at which the specified timing parameters are guaranteed.

⁴ t_{PHL} propagation delay is measured from the 50% level of the falling edge of the V_{ix} signal to the 50% level of the falling edge of the V_{ox} signal. t_{PLH} propagation delay is measured from the 50% level of the rising edge of the V_{ix} signal to the 50% level of the rising edge of the V_{ox} signal.

⁵ Channel-to-channel matching, rising or falling edges, is the magnitude of the propagation delay difference between two channels of the same part when the inputs are either both rising or falling edges. The supply voltages and the loads on each channel are equal.

⁶ Channel-to-channel matching, rising vs. falling edges, is the magnitude of the propagation delay difference between two channels of the same part when one input is a rising edge and the other input is a falling edge. The supply voltages and loads on each channel are equal.

⁷ Part-to-part matching, rising or falling edges, is the magnitude of the propagation delay difference between the same channels of two different parts when the inputs are either both rising or falling edges. The supply voltages, temperatures, and loads of each part are equal.

⁸ Part-to-part matching, rising vs. falling edges, is the magnitude of the propagation delay difference between the same channels of two different parts when one input is a rising edge and the other input is a falling edge. The supply voltages, temperatures, and loads of each part are equal.

PACKAGE CHARACTERISTICS

Table 2.

| Parameter | Symbol | Min | Typ | Max | Unit | Test Conditions/Comments |
|--|------------------|-----|------------------|-----|------|--------------------------|
| Resistance (Input-to-Output) ¹ | R _{I-O} | | 10 ¹² | | Ω | f = 1 MHz |
| Capacitance (Input-to-Output) ¹ | C _{I-O} | | 2.0 | | pF | |
| Input Capacitance | C _I | | 4.0 | | pF | |
| IC Junction-to-Ambient Thermal Resistance | θ _{JA} | | 76 | | °C/W | |

¹ The device is considered a 2-terminal device: Pin 1 through Pin 8 are shorted together, and Pin 9 through Pin 16 are shorted together.

INSULATION AND SAFETY-RELATED SPECIFICATIONS

Table 3.

| Parameter | Symbol | Value | Unit | Test Conditions/Comments |
|---|-------------------|-----------|--------|--|
| Rated Dielectric Insulation Voltage | | 1000 | V rms | 1 minute duration |
| Minimum External Air Gap (Clearance) | L(I01) | 4.0 min | mm | Measured from input terminals to output terminals, shortest distance through air |
| Minimum External Tracking (Creepage) | L(I02) | 4.0 min | mm | Measured from input terminals to output terminals, shortest distance path along body |
| Minimum Internal Gap (Internal Clearance) | | 0.025 min | mm | Insulation distance through insulation |
| Tracking Resistance (Comparative Tracking Index) | CTI | >600 | V | DIN IEC 112/VDE 0303, Part 1 |
| Isolation Group | | I | | Material Group (DIN VDE 0110, 1/89, Table 1) |
| Maximum Working Voltage Compatible with 50 Years Service Life | V _{IORM} | 354 | V peak | Continuous peak voltage across the isolation barrier |

RECOMMENDED OPERATING CONDITIONS

Table 4.

| Parameter | Symbol | Min | Max | Unit |
|--|-------------------------------------|-----|------|-------|
| Operating Temperature | T _A | -40 | +105 | °C |
| Input Supply Voltage ¹ | V _{DD1} | 4.5 | 5.5 | V |
| Output Supply Voltages ¹ | V _{DDA} , V _{DDB} | 12 | 18 | V |
| Input Signal Rise and Fall Times | | | 100 | ns |
| Common-Mode Transient Immunity ² | | | | |
| Input-to-Output | | -35 | +35 | kV/μs |
| Between Outputs | | -35 | +35 | kV/μs |
| Transient Immunity, Supply Voltages ² | | -35 | +35 | kV/μs |

¹ All voltages are relative to their respective grounds.

² See the Common-Mode Transient Immunity section for more information.

REGULATORY INFORMATION

The ADuM7234 is approved by the organization listed in Table 5.

Table 5.

| UL |
|---|
| Recognized under UL 1577 component recognition program ¹ |
| Single/basic insulation, 1000 V rms isolation voltage |
| File E214100 |

¹ In accordance with UL 1577, each ADuM7234 is proof tested by applying an insulation test voltage of 1200 V rms for 1 sec (current leakage detection limit = 5 μA).

ABSOLUTE MAXIMUM RATINGS

Ambient temperature = 25°C, unless otherwise noted.

Table 6.

| Parameter | Rating |
|---|--------------------------------------|
| Storage Temperature (T_{ST}) | -55°C to +150°C |
| Ambient Operating Temperature (T_A) | -40°C to +105°C |
| Input Supply Voltage (V_{DD1}) ¹ | -0.5 V to +7.0 V |
| Output Supply Voltage ¹ (V_{DDA} , V_{DDB}) | -0.5 V to +27 V |
| Input Voltage ¹ (V_{IA} , V_{IB}) | -0.5 V to $V_{DD1} + 0.5$ V |
| Output Voltage ¹ V_{OA} | -0.5 V to $V_{DDA} + 0.5$ V |
| V_{OB} | -0.5 V to $V_{DDB} + 0.5$ V |
| Input-to-Output Voltage ² | -350 V peak to +350 V peak |
| Output Differential Voltage ³ | 350 V peak |
| Output DC Current (I_{OA} , I_{OB}) | -800 mA to +800 mA |
| Common-Mode Transients ⁴ | -100 kV/ μ s to +100 kV/ μ s |

¹ All voltages are relative to their respective grounds.

² Input-to-output voltage is defined as $GND_A - GND_1$ or $GND_B - GND_1$.

³ Output differential voltage is defined as $GND_A - GND_B$.

⁴ Refers to common-mode transients across any insulation barrier. Common-mode transients exceeding the absolute maximum ratings may cause latch-up or permanent damage.

Stresses above those listed under Absolute Maximum Ratings may cause permanent damage to the device. This is a stress rating only; functional operation of the device at these or any other conditions above those indicated in the operational section of this specification is not implied. Exposure to absolute maximum rating conditions for extended periods may affect device reliability.

ESD CAUTION



ESD (electrostatic discharge) sensitive device. Charged devices and circuit boards can discharge without detection. Although this product features patented or proprietary protection circuitry, damage may occur on devices subjected to high energy ESD. Therefore, proper ESD precautions should be taken to avoid performance degradation or loss of functionality.

PIN CONFIGURATION AND FUNCTION DESCRIPTIONS

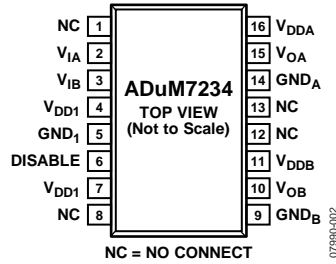

Figure 2. Pin Configuration

Table 7. Pin Function Descriptions

| Pin No. | Mnemonic | Description |
|--------------|------------------|--|
| 1, 8, 12, 13 | NC | No Connect. Pin 12 and Pin 13 are floating and should be left unconnected. |
| 2 | V _{IA} | Logic Input A. |
| 3 | V _{IB} | Logic Input B. |
| 4, 7 | V _{DD1} | Input Supply Voltage, 4.5 V to 5.5 V. Pin 4 and Pin 7 are internally connected. Connecting both pins to V _{DD1} is recommended. |
| 5 | GND ₁ | Ground Reference for Input Logic Signals. |
| 6 | DISABLE | Input Disable. Disables the isolator inputs and refresh circuits. Outputs take on the default low state. |
| 9 | GND _B | Ground Reference for Output B. |
| 10 | V _{OB} | Output B. |
| 11 | V _{DDB} | Output B Supply Voltage, 12 V to 18 V. |
| 14 | GND _A | Ground Reference for Output A. |
| 15 | V _{OA} | Output A. |
| 16 | V _{DDA} | Output A Supply Voltage, 12 V to 18 V. |

Table 8. Truth Table (Positive Logic)

| V _{IA} /V _{IB} Input | V _{DD1} State | DISABLE | V _{OA} /V _{OB} Output | Notes |
|--|------------------------|----------------|---|---|
| High | Powered | Low | High | Output returns to the input state within 1 μs of V _{DD1} power restoration |
| Low | Powered | Low | Low | |
| X ¹ | Unpowered | X ¹ | Low | |
| X ¹ | Powered | High | Low | |

¹ X is don't care.

TYPICAL PERFORMANCE CHARACTERISTICS

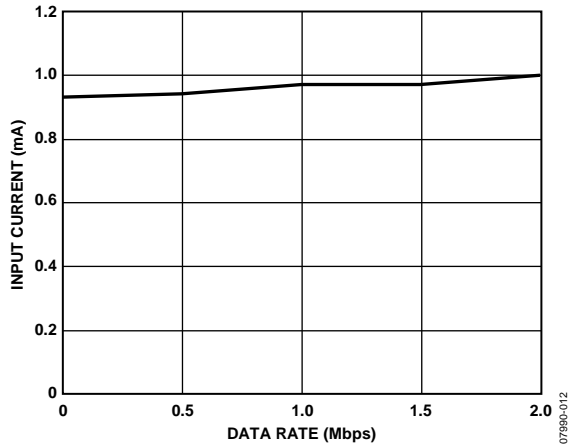

Figure 3. Typical Input Supply Current Variation with Data Rate

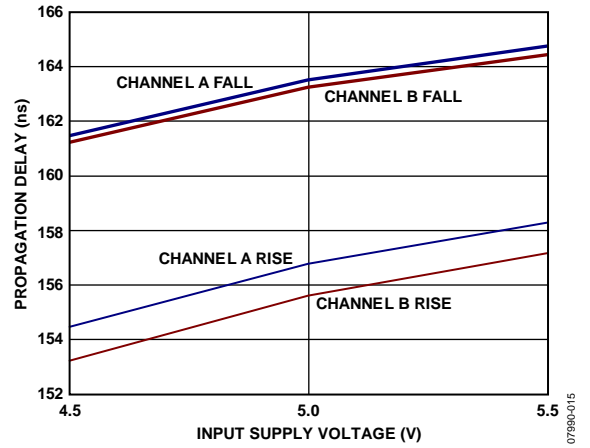

Figure 6. Typical Propagation Delay Variation with Input Supply Voltage (Output Supply Voltage = 15.0 V)

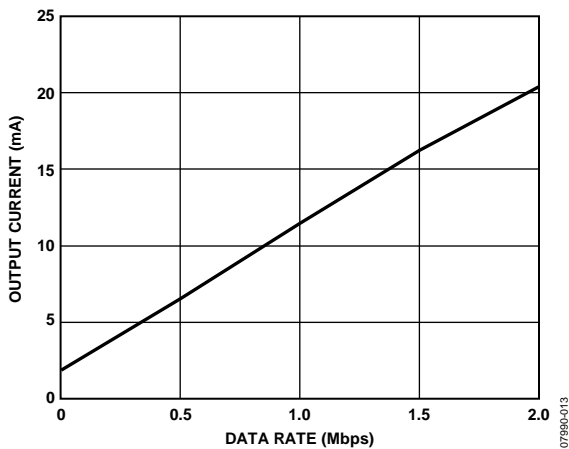

Figure 4. Typical Output Supply Current Variation with Data Rate

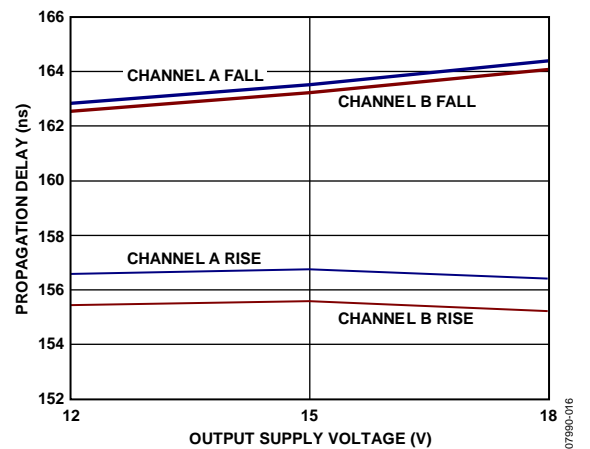

Figure 7. Typical Propagation Delay Variation with Output Supply Voltage (Input Supply Voltage = 5.0 V)

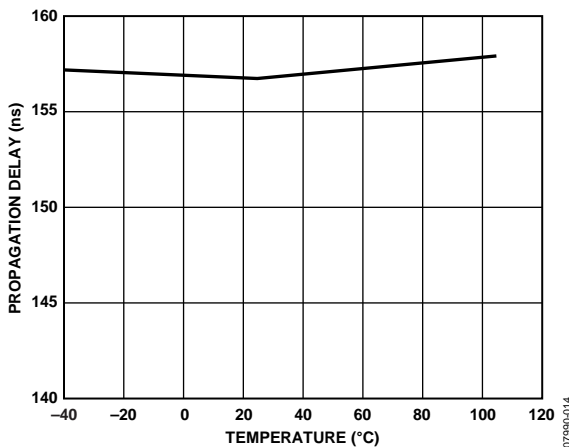

Figure 5. Typical Propagation Delay Variation with Temperature

APPLICATIONS INFORMATION

COMMON-MODE TRANSIENT IMMUNITY

In general, common-mode transients consist of linear and sinusoidal components. The linear component of a common-mode transient is given by

$$V_{CM, linear} = (\Delta V/\Delta t)t$$

where $\Delta V/\Delta t$ is the slope of the transient shown in Figure 11 and Figure 12.

The transient of the linear component is given by

$$dV_{CM}/dt = \Delta V/\Delta t$$

Figure 8 characterizes the ability of the ADuM7234 to operate correctly in the presence of linear transients. The data, based on design simulation, is the maximum linear transient magnitude that the ADuM7234 can tolerate without an operational error. This data shows a correlation with the data that is listed in Table 4, which is based on measured data.

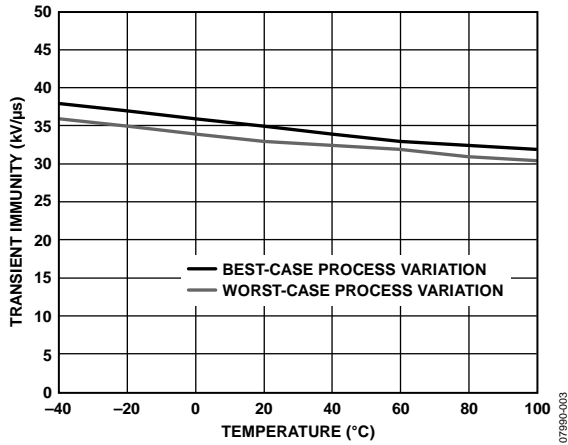

Figure 8. Transient Immunity (Linear Transients) vs. Temperature

The sinusoidal component (at a given frequency) is given by

$$V_{CM, sinusoidal} = V_0 \sin(2\pi ft)$$

where:

V_0 is the magnitude of the sinusoidal.

f is the frequency of the sinusoidal.

The transient magnitude of the sinusoidal component is given by

$$dV_{CM}/dt = 2\pi f V_0$$

Figure 9 and Figure 10 characterize the ability of the ADuM7234 to operate correctly in the presence of sinusoidal transients. The data is based on design simulation and is the maximum sinusoidal transient magnitude ($2\pi f V_0$) that the ADuM7234 can tolerate without an operational error. Values for immunity against sinusoidal transients are not included in Table 4 because measurements to obtain such values have not been possible.

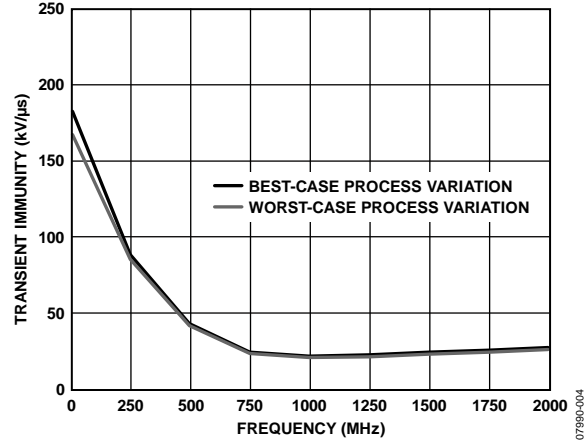

Figure 9. Transient Immunity (Sinusoidal Transients), 27°C Ambient Temperature

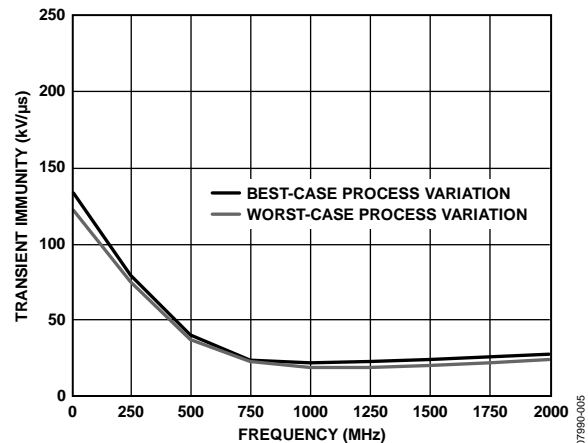

Figure 10. Transient Immunity (Sinusoidal Transients), 100°C Ambient Temperature

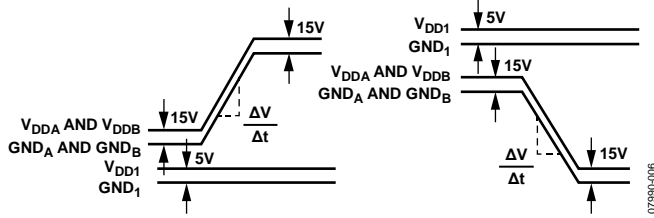

Figure 11. Common-Mode Transient Immunity Waveforms, Input to Output

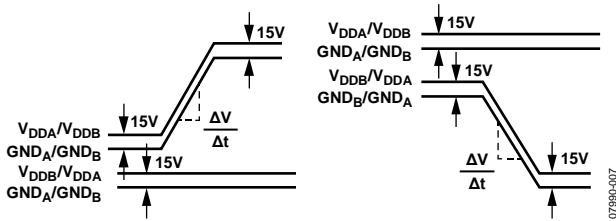

Figure 12. Common-Mode Transient Immunity Waveforms Between Outputs

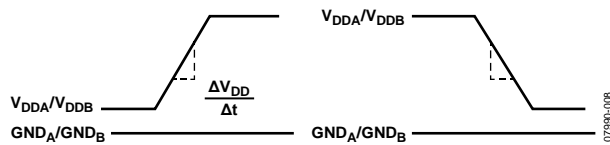

Figure 13. Transient Immunity Waveforms, Output Supplies

INSULATION LIFETIME

All insulation structures eventually break down when subjected to voltage stress over a sufficiently long period. The rate of insulation degradation depends on the characteristics of the voltage waveform applied across the insulation. In addition to the testing performed by the regulatory agencies, Analog Devices conducts an extensive set of evaluations to determine the lifetime of the insulation structure within the ADuM7234.

Analog Devices performs accelerated life testing using voltage levels higher than the rated continuous working voltage. Acceleration factors for several operating conditions are determined. These factors allow calculation of the time to failure at the actual working voltage. Table 3 lists the peak voltage for 50 years of service life for a bipolar ac operating condition and the maximum Analog Devices recommended working voltage. In many cases, the approved working voltage is higher than the 50-year service life voltage. Operation at these high working voltages can lead to shortened insulation life in some cases.

The insulation lifetime of the ADuM7234 depends on the voltage waveform type imposed across the isolation barrier. The iCoupler insulation structure degrades at different rates depending on whether the waveform is bipolar ac, unipolar ac, or dc. Figure 14, Figure 15, and Figure 16 illustrate these different isolation voltage waveforms.

Bipolar ac voltage is the most stringent environment. The goal of a 50-year operating lifetime under the bipolar ac condition determines the maximum working voltage recommended by Analog Devices.

In the case of unipolar ac or dc voltage, the stress on the insulation is significantly lower. This allows operation at higher working voltages while still achieving a 50-year service life. The working voltage listed in Table 3 can be applied while maintaining the 50-year minimum lifetime, provided that the voltage conforms to either the unipolar ac or dc voltage cases. Any cross-insulation voltage waveform that does not conform to Figure 15 or Figure 16 should be treated as a bipolar ac waveform, and its peak voltage should be limited to the 50-year lifetime voltage value listed in Table 3.

Note that the voltage presented in Figure 15 is shown as sinusoidal for illustration purposes only. It is meant to represent any voltage waveform varying between 0 V and some limiting value. The limiting value can be positive or negative, but the voltage cannot cross 0 V.

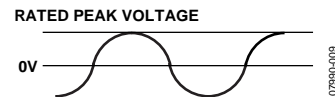

Figure 14. Bipolar AC Waveform

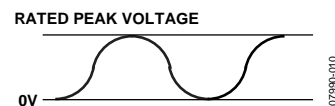

Figure 15. Unipolar AC Waveform

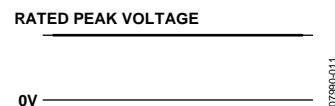
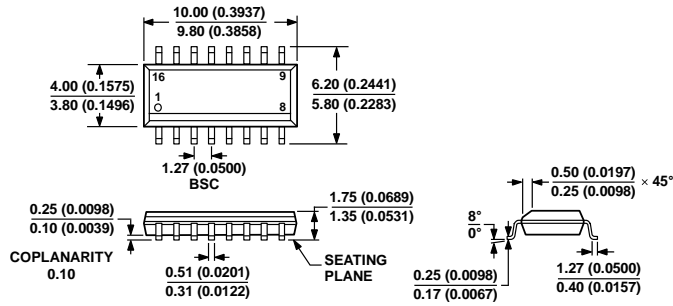

Figure 16. DC Waveform

OUTLINE DIMENSIONS



COMPLIANT TO JEDEC STANDARDS MS-012-AC
 CONTROLLING DIMENSIONS ARE IN MILLIMETERS; INCH DIMENSIONS
 (IN PARENTHESES) ARE ROUNDED-OFF MILLIMETER EQUIVALENTS FOR
 REFERENCE ONLY AND ARE NOT APPROPRIATE FOR USE IN DESIGN.

0001008-A

Figure 17. 16-Lead Standard Small Outline Package [SOIC_N]
 Narrow Body
 (R-16)

Dimensions shown in millimeters and (inches)

ORDERING GUIDE

| Model ¹ | Number of Channels | Output Peak Current (A) | Output Voltage (V) | Temperature Range | Package Description | Package Option |
|--------------------|--------------------|-------------------------|--------------------|-------------------|---|----------------|
| ADuM7234BRZ | 2 | 4 | 15 | -40°C to +105°C | 16-Lead SOIC_N | R-16 |
| ADuM7234BRZ-RL7 | 2 | 4 | 15 | -40°C to +105°C | 16-Lead SOIC_N, 7-Inch Tape and Reel Option (1,000 Units) | R-16 |

¹ Z = RoHS Compliant Part.

NOTES

NOTES

Mouser Electronics

Authorized Distributor

Click to View Pricing, Inventory, Delivery & Lifecycle Information:

[Analog Devices Inc.:](#)

[ADUM7234BRZ-RL7](#) [ADUM7234BRZ](#)